



	1	2	3	4	5	6	7	8	9	10	11	12	13	14																												
A					<h3>RJ45-Netzwerkkabel der Kategorie 8.1</h3> <ul style="list-style-type: none"> <li>- LAN-Kabel unterstützt 25GBase-T und 40GBase-T Ethernet-Netzwerke (40-gigabitfähig) und ist abwärtskompatibel zu 10BASE-T, 100BASE-TX und 1000BASE-T</li> <li>- mit einer Übertragungsbandbreite von bis zu 2.000 MHz besitzt das Ethernetkabel die 4-fache Bandbreite von CAT-6A-Kabeln</li> <li>- S/FTP-Gesamtschirmung: Aluminium-Folienschirmung für einzelne Adernpaare (PiMF) und Aluminium-Geflechschirmung für den Kabelmantel</li> <li>- beidseitig ausgestattet mit RJ45-Steckern (8P8C) mit 50 µm vergoldeten Kontaktflächen und Rastnasenschutz</li> <li>- CAT-8-LAN-Kabel ist für Power over Ethernet (PoE, PoE+, UPoE, 4PPoE) und HDBaseT geeignet.</li> <li>- raucharmer und halogenfreier LSZH-Kabelmantel für erhöhte Sicherheit</li> <li>- die Produkte sind nur mit einem Papieretikett gekennzeichnet, auf Plastiktüten und Kunststoffkabelbinder wird verzichtet</li> <li>- gilt nur für Kabel mit einer Länge von bis zu 3 m: GHMT-zertifiziert für eine Übertragungsstrecke von 1x 24 m Verlegekabel plus 2x 3 m Patchcord im 2-Connector Channel (8.1-Standard Class I mit einer Betriebsfrequenz bis zu 2 GHz)</li> </ul>					<h3>RJ45 Network Cable Category 8.1</h3> <ul style="list-style-type: none"> <li>- the LAN cable supports 25GBase-T and 40GBase-T Ethernet networks (40-gigabit capable) and is backwards compatible with 10BASE-T, 100BASE-TX and 1000BASE-T.</li> <li>- with a transmission bandwidth of up to 2,000 MHz, the Ethernet cable has 4 times the bandwidth of a CAT 6A cable</li> <li>- S/FTP overall shield: aluminium foil shield for individual wire pairs (PiMF) and aluminium braid shield for the cable sheath</li> <li>- assembled on both ends with RJ45 connectors (8P8C) with 50 µm gold-plated contact surfaces and latch protection</li> <li>- CAT 8 LAN cable is suitable for Power over Ethernet (PoE, PoE+, UPoE, 4PPoE) and HDBaseT</li> <li>- low-smoke and halogen-free LSZH cable sheath for increased safety</li> <li>- the products are only labelled with a paper label, plastic bags and plastic cable ties are not used</li> <li>- only applies to cables up to 3 m long: GHMT-certified for a transmission distance of 1x 24 m installation cable plus 2x 3 m patch cord in a 2-connector channel (8.1 Standard Class I with an operating frequency of up to 2 GHz)</li> </ul>																																
B																																										
C																																										
D																																										
E																																										
F					<b>Spezifikation:</b> CAT 8.1 <b>Kabeltyp:</b> CAT-8.1-Rohkabel <b>Material Innenleiter:</b> CU (Kupfer) <b>AWG:</b> 26/7 (stranded) <b>Schirmungsklasse:</b> S/FTP (PiMF) <b>Anzahl Schirmungen:</b> 2x <b>Schirmung Typ 1:</b> Folie (Aluminium) PiMF <b>Schirmung Typ 2:</b> Geflecht (Aluminium) Gesamtschirm <b>Material Kabelmantel:</b> LSZH <b>Durchmesser Kabelmantel:</b> ca. 6,2 mm <b>LSZH-konform:</b> ja <b>Knickschutz:</b> beidseitig <b>Anschlüsse:</b> 2x RJ45-Stecker (8P8C) <b>Anschluss Schirmung:</b> ja <b>Kontakte:</b> vergoldet (50 µm) <b>Gehäusematerial:</b> PVC <b>Rastnasenschutz:</b> beidseitig <b>Kontaktierung:</b> EIA/TIA-568B					<b>Specification:</b> CAT 8.1 <b>Cable type:</b> CAT 8.1 raw cable <b>Inner conductor material:</b> CU (copper) <b>AWG:</b> 26/7 (stranded) <b>Shielding class:</b> S/FTP (PiMF) <b>Number of shieldings:</b> 2x <b>Shielding type 1:</b> Foil (aluminium) PiMF <b>Shielding type 2:</b> Braid (aluminium) overall shield <b>Cable sheath material:</b> LSZH <b>Cable sheath diameter:</b> (approx.) 6.2 mm <b>LSZH-compliant:</b> yes <b>Kink protection:</b> both sides <b>Connections:</b> 2x RJ45 male (8P8C) <b>Connection shielding:</b> yes <b>Contacts:</b> gold-plated (50 µm) <b>Housing material:</b> PVC <b>Latch protection:</b> both sides <b>Contacting:</b> EIA/TIA-568B																																
G																																										
H																																										
I	<table border="1"> <thead> <tr> <th colspan="2">Änderungen</th><th>Datum</th><th>Name</th></tr> </thead> <tbody> <tr> <td>Datum</td><td>Name</td><td>gez.: 01.02.2023</td><td>ir</td></tr> <tr> <td></td><td></td><td>gepr.: 01.02.2023</td><td>aw</td></tr> <tr> <td></td><td></td><td>Norm:</td><td></td></tr> </tbody> </table>				Änderungen		Datum	Name	Datum	Name	gez.: 01.02.2023	ir			gepr.: 01.02.2023	aw			Norm:		<table border="1"> <thead> <tr> <th>Bezeichnung</th><th>Blatt</th></tr> </thead> <tbody> <tr> <td>CAT 8.1-XXXX S/FTP AWG26 LSZH X Xm</td><td>1/3</td></tr> <tr> <td>Zeichnungs-Nr.:</td><td>von</td></tr> </tbody> </table>					Bezeichnung	Blatt	CAT 8.1-XXXX S/FTP AWG26 LSZH X Xm	1/3	Zeichnungs-Nr.:	von											
Änderungen		Datum	Name																																							
Datum	Name	gez.: 01.02.2023	ir																																							
		gepr.: 01.02.2023	aw																																							
		Norm:																																								
Bezeichnung	Blatt																																									
CAT 8.1-XXXX S/FTP AWG26 LSZH X Xm	1/3																																									
Zeichnungs-Nr.:	von																																									
Änderungen vorbehalten / Subject to change																																										
J	1	2	3	4	5	6	7	8	9	10	11	12	13	14	J																											



L

**Aderquerschnitt / Wire cross section**

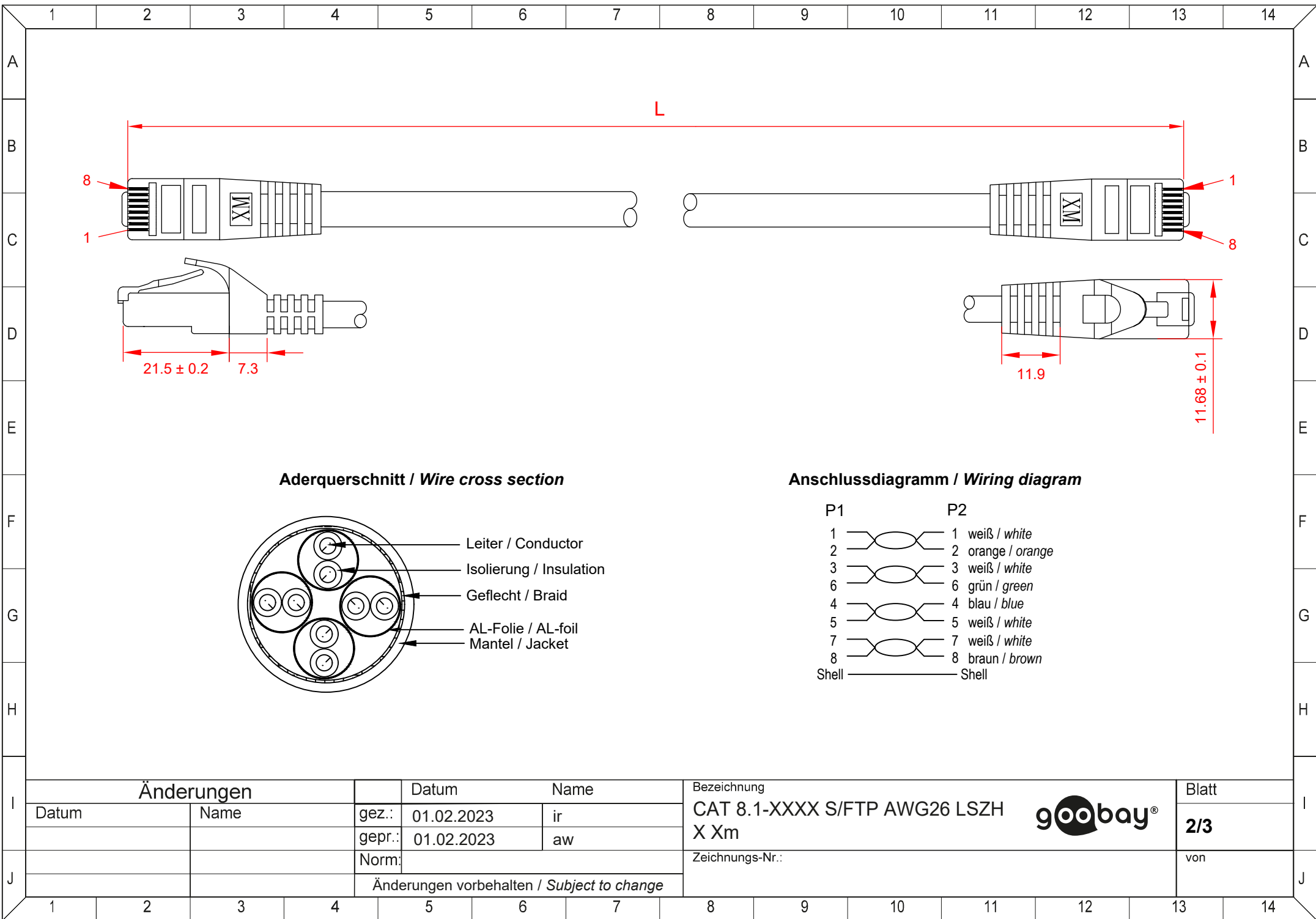
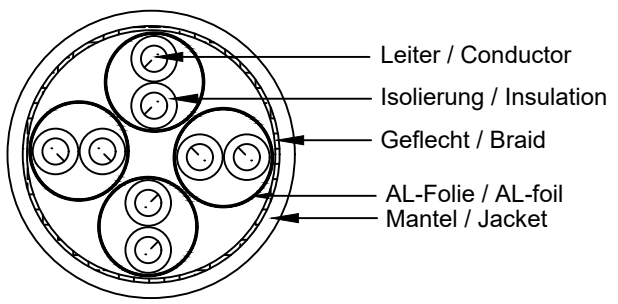

**Anschlussdiagramm / Wiring diagram**

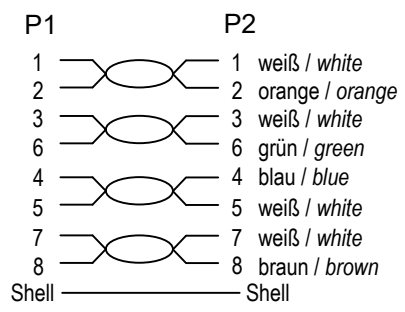

21.5 ± 0.2    7.3

11.9

11.68 ± 0.1

**Änderungen**

Änderungen		Datum	Name
Datum	Name	gez.: 01.02.2023	ir
		gepr.: 01.02.2023	aw
		Norm:	
Änderungen vorbehalten / Subject to change			

Bezeichnung	<b>goobay®</b>	Blatt
CAT 8.1-XXXX S/FTP AWG26 LSZH X Xm		<b>2/3</b>
Zeichnungs-Nr.:		von

	1	2	3	4	5	6	7	8	9	10	11	12	13	14		
A	<b>Art.-Nr. / Item No.</b>	<b>ERP Name / ERP Name</b>				<b>Produktname / Product Name</b>				<b>GHMT-Zertifizierung / GHMT certification</b>		<b>Länge / Length (L)</b>		<b>Farbe / Colour</b>		
B	61091	CAT 8.1-0025 S/FTP AWG26 LSZH BLACK 0.25m GHMT				GHMT-zertifiziertes CAT 8.1 Patchkabel, S/FTP (PiMF) / GHMT-certified CAT 8.1 S/FTP Patch Cord				ja / yes		250 ± 10 mm		schwarz / black		
	61092	CAT 8.1-0050 S/FTP AWG26 LSZH BLACK 0.50m GHMT										500 ± 20 mm				
	61093	CAT 8.1-0100 S/FTP AWG26 LSZH BLACK 1m GHMT										1000 ± 20 mm				
	61094	CAT 8.1-0200 S/FTP AWG26 LSZH BLACK 2m GHMT										2000 ± 30 mm				
	61095	CAT 8.1-0300 S/FTP AWG26 LSZH BLACK 3m GHMT										3000 ± 50 mm				
C	61096	CAT 8.1-0500 S/FTP AWG26 LSZH BLACK 5m				CAT-8.1-Patchkabel, S/FTP (PiMF) / CAT 8.1 S/FTP Patch Cord				nein / no		5000 ± 100 mm				
	61097	CAT 8.1-0750 S/FTP AWG26 LSZH BLACK 7.5m				7500 ± 150 mm										
	61098	CAT 8.1-1000 S/FTP AWG26 LSZH BLACK 10m				10000 ± 300 mm										
	61099	CAT 8.1-1500 S/FTP AWG26 LSZH BLACK 15m				15000 ± 300 mm										
D	61100	CAT 8.1-2000 S/FTP AWG26 LSZH BLACK 20m				RJ45-Patchkabel mit CAT 8.1 S/FTP Rohkabel / RJ45 Patch Cord with CAT 8.1 S/FTP Raw Cable				20000 ± 300 mm						
	61102	CAT 8.1-0025 S/FTP AWG26 LSZH WHITE 0.25m GHMT				GHMT-zertifiziertes CAT 8.1 Patchkabel, S/FTP (PiMF) / GHMT-certified CAT 8.1 S/FTP Patch Cord				ja / yes		250 ± 10 mm		weiß / white		
E	61103	CAT 8.1-0050 S/FTP AWG26 LSZH WHITE 0.50m GHMT										500 ± 20 mm				
	61104	CAT 8.1-0100 S/FTP AWG26 LSZH WHITE 1m GHMT										1000 ± 20 mm				
F	61105	CAT 8.1-0200 S/FTP AWG26 LSZH WHITE 2m GHMT										2000 ± 30 mm				
	61106	CAT 8.1-0300 S/FTP AWG26 LSZH WHITE 3m GHMT										3000 ± 50 mm				
	61107	CAT 8.1-0500 S/FTP AWG26 LSZH WHITE 5m				CAT-8.1-Patchkabel, S/FTP (PiMF) / CAT 8.1 S/FTP Patch Cord				5000 ± 100 mm		nein / no				
G	61108	CAT 8.1-0750 S/FTP AWG26 LSZH WHITE 7.5m				7500 ± 150 mm										
	61109	CAT 8.1-1000 S/FTP AWG26 LSZH WHITE 10m				10000 ± 300 mm										
	61110	CAT 8.1-1500 S/FTP AWG26 LSZH WHITE 15m				15000 ± 300 mm										
H	61111	CAT 8.1-2000 S/FTP AWG26 LSZH WHITE 20m				RJ45-Patchkabel mit CAT 8.1 S/FTP Rohkabel / RJ45 Patch Cord with CAT 8.1 S/FTP Raw Cable				20000 ± 300 mm						
	I	61113	CAT 8.1-0025 S/FTP AWG26 LSZH GREY 0.25m GHMT				GHMT-zertifiziertes CAT 8.1 Patchkabel, S/FTP (PiMF) / GHMT-certified CAT 8.1 S/FTP Patch Cord				ja / yes		250 ± 10 mm		grau / grey	
		61114	CAT 8.1-0050 S/FTP AWG26 LSZH GREY 0.50m GHMT										500 ± 20 mm			
		61115	CAT 8.1-0100 S/FTP AWG26 LSZH GREY 1m GHMT										1000 ± 20 mm			
61116	CAT 8.1-0200 S/FTP AWG26 LSZH GREY 2m GHMT				2000 ± 30 mm											
J	61117	CAT 8.1-0300 S/FTP AWG26 LSZH GREY 3m GHMT				3000 ± 50 mm		nein / no		5000 ± 100 mm						
	61118	CAT 8.1-0500 S/FTP AWG26 LSZH GREY 5m				CAT-8.1-Patchkabel, S/FTP (PiMF) / CAT 8.1 S/FTP Patch Cord				7500 ± 150 mm						
	61119	CAT 8.1-0750 S/FTP AWG26 LSZH GREY 7.5m				10000 ± 300 mm										
	61120	CAT 8.1-1000 S/FTP AWG26 LSZH GREY 10m				15000 ± 300 mm										
K	61121	CAT 8.1-1500 S/FTP AWG26 LSZH GREY 15m				RJ45-Patchkabel mit CAT 8.1 S/FTP Rohkabel / RJ45 Patch Cord with CAT 8.1 S/FTP Raw Cable				20000 ± 300 mm						
	61122	CAT 8.1-2000 S/FTP AWG26 LSZH GREY 20m														
L	<b>Änderungen</b>				<b>Datum</b>		<b>Name</b>		<b>Bezeichnung</b>				<b>Blatt</b>			
	Datum		Name		gez.:	01.02.2023	ir	CAT 8.1-XXXX S/FTP AWG26 LSZH								
					gepr.:	01.02.2023	aw	X Xm								
					Norm:			Zeichnungs-Nr.:				von				
				Änderungen vorbehalten / Subject to change												
	1	2	3	4	5	6	7	8	9	10	11	12	13	14		