



	1	2	3	4	5	6	7	8	9	10	11	12	13	14																			
A					<h3>RJ45-Netzwerkkabel der Kategorie 8.1</h3> <ul style="list-style-type: none"> - LAN-Kabel unterstützt 25GBase-T und 40GBase-T Ethernet-Netzwerke (40-gigabitfähig) und ist abwärtskompatibel zu 10BASE-T, 100BASE-TX und 1000BASE-T - mit einer Übertragungsbandbreite von bis zu 2.000 MHz besitzt das Ethernetkabel die 4-fache Bandbreite von CAT-6A-Kabeln - S/FTP-Gesamtschirmung: Aluminium-Folienschirmung für einzelne Adernpaare (PiMF) und Aluminium-Geflechschirmung für den Kabelmantel - beidseitig ausgestattet mit RJ45-Steckern (8P8C) mit 50 µm vergoldeten Kontaktflächen und Rastnasenschutz - CAT-8-LAN-Kabel ist für Power over Ethernet (PoE, PoE+, UPoE, 4PPoE) und HDBaseT geeignet. - raucharmer und halogenfreier LSZH-Kabelmantel für erhöhte Sicherheit - die Produkte sind nur mit einem Papieretikett gekennzeichnet, auf Plastiktüten und Kunststoffkabelbinder wird verzichtet - gilt nur für Kabel mit einer Länge von bis zu 3 m: GHMT-zertifiziert für eine Übertragungsstrecke von 1x 24 m Verlegekabel plus 2x 3 m Patchcord im 2-Connector Channel (8.1-Standard Class I mit einer Betriebsfrequenz bis zu 2 GHz) 				<h3>RJ45 Network Cable Category 8.1</h3> <ul style="list-style-type: none"> - the LAN cable supports 25GBase-T and 40GBase-T Ethernet networks (40-gigabit capable) and is backwards compatible with 10BASE-T, 100BASE-TX and 1000BASE-T. - with a transmission bandwidth of up to 2,000 MHz, the Ethernet cable has 4 times the bandwidth of a CAT 6A cable - S/FTP overall shield: aluminium foil shield for individual wire pairs (PiMF) and aluminium braid shield for the cable sheath - assembled on both ends with RJ45 connectors (8P8C) with 50 µm gold-plated contact surfaces and latch protection - CAT 8 LAN cable is suitable for Power over Ethernet (PoE, PoE+, UPoE, 4PPoE) and HDBaseT - low-smoke and halogen-free LSZH cable sheath for increased safety - the products are only labelled with a paper label, plastic bags and plastic cable ties are not used - only applies to cables up to 3 m long: GHMT-certified for a transmission distance of 1x 24 m installation cable plus 2x 3 m patch cord in a 2-connector channel (8.1 Standard Class I with an operating frequency of up to 2 GHz) 				A																				
B																	B																
C																	C																
D													D																				
E													E																				
F					Spezifikation: Kabeltyp: CAT 8.1 Material Innenleiter: CU (Kupfer) AWG: 26/7 (stranded) Schirmungsklasse: S/FTP (PiMF) Anzahl Schirmungen: 2x Schirmung Typ 1: Folie (Aluminium) PiMF Schirmung Typ 2: Geflecht (Aluminium) Gesamtschirm Material Kabelmantel: LSZH Durchmesser Kabelmantel: ca. 6,2 mm LSZH-konform: ja Knickschutz: beidseitig Anschlüsse: 2x RJ45-Stecker (8P8C) Anschluss Schirmung: ja Kontakte: vergoldet (50 µm) Gehäusematerial: PVC Rastnasenschutz: beidseitig Kontaktierung: EIA/TIA-568B				Specification: Cable type: CAT 8.1 raw cable Inner conductor material: CU (copper) AWG: 26/7 (stranded) Shielding class: S/FTP (PiMF) Number of shieldings: 2x Shielding type 1: Foil (aluminium) PiMF Shielding type 2: Braid (aluminium) overall shield Cable sheath material: LSZH Cable sheath diameter: (approx.) 6.2 mm LSZH-compliant: yes Kink protection: both sides Connections: 2x RJ45 male (8P8C) Connection shielding: yes Contacts: gold-plated (50 µm) Housing material: PVC Latch protection: both sides Contacting: EIA/TIA-568B				F																				
G																	G																
H																	H																
I	<table border="1"> <thead> <tr> <th colspan="2">Änderungen</th> <th>Datum</th> <th>Name</th> </tr> </thead> <tbody> <tr> <td>Datum</td> <td>Name</td> <td>gez.:</td> <td>01.02.2023</td> </tr> <tr> <td></td> <td></td> <td>gepr.:</td> <td>01.02.2023</td> </tr> <tr> <td></td> <td></td> <td>Norm:</td> <td></td> </tr> <tr> <td colspan="4">Änderungen vorbehalten / Subject to change</td> </tr> </tbody> </table>				Änderungen		Datum	Name	Datum	Name	gez.:	01.02.2023			gepr.:	01.02.2023			Norm:		Änderungen vorbehalten / Subject to change				Datum Name Bezeichnung CAT 8.1-XXXX S/FTP AWG26 LSZH X Xm Zeichnungs-Nr.:				Blatt  1/3 von				I
Änderungen		Datum	Name																														
Datum	Name	gez.:	01.02.2023																														
		gepr.:	01.02.2023																														
		Norm:																															
Änderungen vorbehalten / Subject to change																																	
J													J																				
	1	2	3	4	5	6	7	8	9	10	11	12	13	14																			



L

Aderquerschnitt / Wire cross section

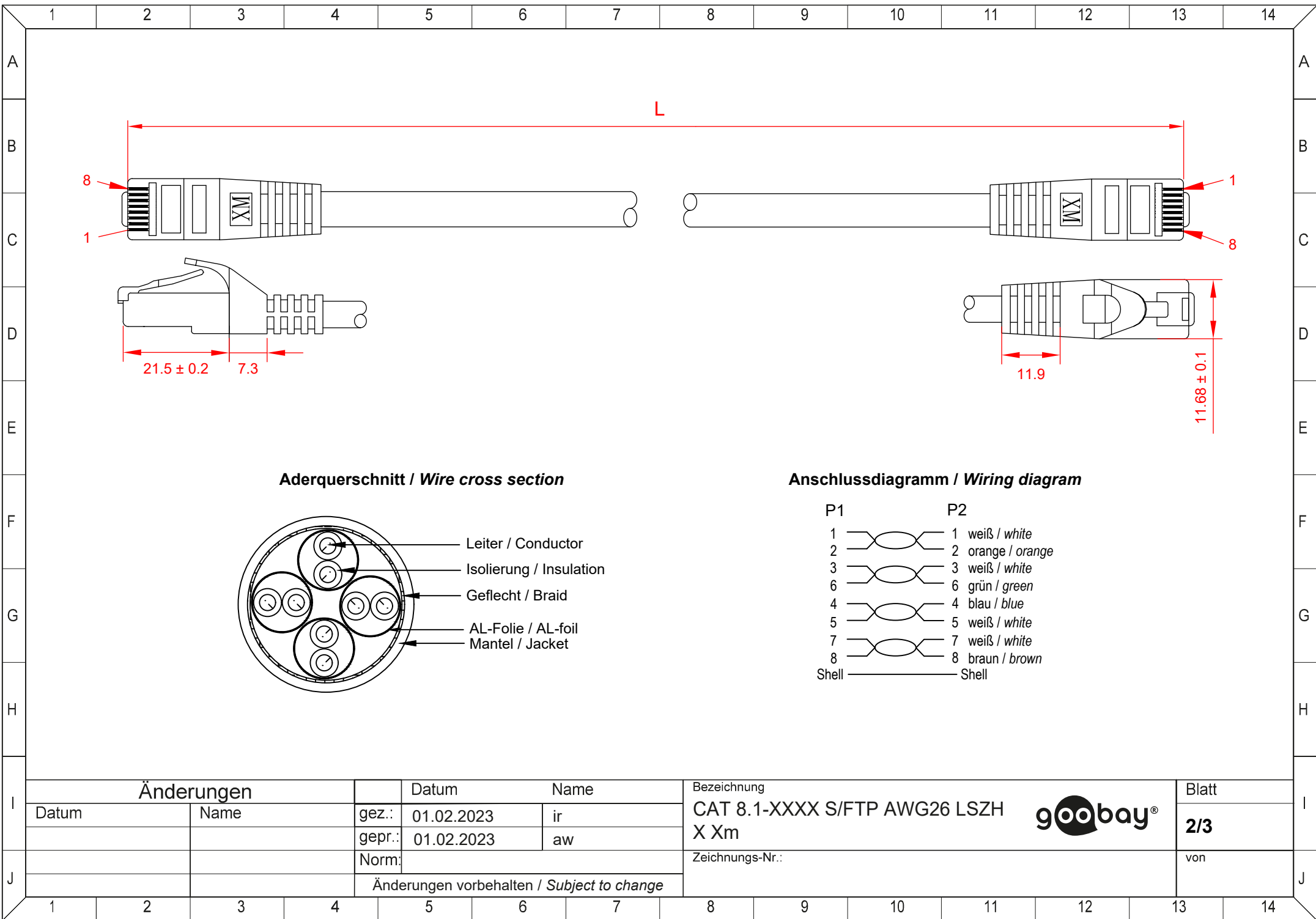
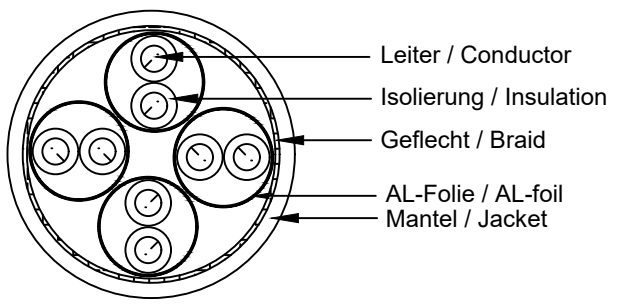

Anschlussdiagramm / Wiring diagram

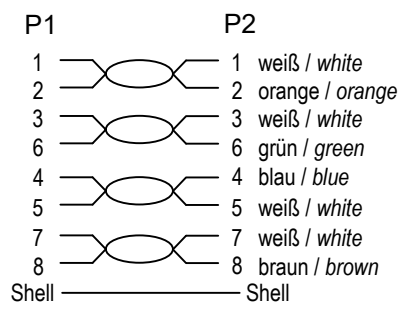

21.5 ± 0.2 7.3

11.9

11.68 ± 0.1

Änderungen

Änderungen		Datum	Name
Datum	Name	gez.: 01.02.2023	ir
		gepr.: 01.02.2023	aw
		Norm:	
Änderungen vorbehalten / Subject to change			

Bezeichnung	goobay®	Blatt
CAT 8.1-XXXX S/FTP AWG26 LSZH X Xm		2/3
Zeichnungs-Nr.:		von

1	2	3	4	5	6	7	8	9	10	11	12	13	14		
A	Art.-Nr. / Item No.	ERP Name / ERP Name			Produktname / Product Name				GHMT-Zertifizierung / GHMT certification		Länge / Length (L)		Farbe / Colour		
B	61091	CAT 8.1-0025 S/FTP AWG26 LSZH BLACK 0.25m GHMT			GHMT-zertifiziertes CAT 8.1 Patchkabel, S/FTP (PiMF) / GHMT-certified CAT 8.1 S/FTP Patch Cord				ja / yes		250 ± 10 mm		schwarz / black		
	61092	CAT 8.1-0050 S/FTP AWG26 LSZH BLACK 0.50m GHMT									500 ± 20 mm				
	61093	CAT 8.1-0100 S/FTP AWG26 LSZH BLACK 1m GHMT									1000 ± 20 mm				
	61094	CAT 8.1-0200 S/FTP AWG26 LSZH BLACK 2m GHMT									2000 ± 30 mm				
	61095	CAT 8.1-0300 S/FTP AWG26 LSZH BLACK 3m GHMT									3000 ± 50 mm				
C	61096	CAT 8.1-0500 S/FTP AWG26 LSZH BLACK 5m			CAT-8.1-Patchkabel, S/FTP (PiMF) / CAT 8.1 S/FTP Patch Cord				nein / no		5000 ± 100 mm				
	61097	CAT 8.1-0750 S/FTP AWG26 LSZH BLACK 7.5m			RJ45-Patchkabel mit CAT 8.1 S/FTP Rohkabel / RJ45 Patch Cord with CAT 8.1 S/FTP Raw Cable						7500 ± 150 mm				
	61098	CAT 8.1-1000 S/FTP AWG26 LSZH BLACK 10m									10000 ± 300 mm				
	61099	CAT 8.1-1500 S/FTP AWG26 LSZH BLACK 15m									15000 ± 300 mm				
	61100	CAT 8.1-2000 S/FTP AWG26 LSZH BLACK 20m									20000 ± 300 mm				
D	61102	CAT 8.1-0025 S/FTP AWG26 LSZH WHITE 0.25m GHMT			GHMT-zertifiziertes CAT 8.1 Patchkabel, S/FTP (PiMF) / GHMT-certified CAT 8.1 S/FTP Patch Cord				ja / yes		250 ± 10 mm		weiß / white		
	61103	CAT 8.1-0050 S/FTP AWG26 LSZH WHITE 0.50m GHMT									500 ± 20 mm				
	61104	CAT 8.1-0100 S/FTP AWG26 LSZH WHITE 1m GHMT									1000 ± 20 mm				
E	61105	CAT 8.1-0200 S/FTP AWG26 LSZH WHITE 2m GHMT			CAT-8.1-Patchkabel, S/FTP (PiMF) / CAT 8.1 S/FTP Patch Cord				nein / no		2000 ± 30 mm				
	61106	CAT 8.1-0300 S/FTP AWG26 LSZH WHITE 3m GHMT									3000 ± 50 mm				
F	61107	CAT 8.1-0500 S/FTP AWG26 LSZH WHITE 5m			CAT-8.1-Patchkabel, S/FTP (PiMF) / CAT 8.1 S/FTP Patch Cord				nein / no		5000 ± 100 mm				
	61108	CAT 8.1-0750 S/FTP AWG26 LSZH WHITE 7.5m			RJ45-Patchkabel mit CAT 8.1 S/FTP Rohkabel / RJ45 Patch Cord with CAT 8.1 S/FTP Raw Cable						7500 ± 150 mm				
	61109	CAT 8.1-1000 S/FTP AWG26 LSZH WHITE 10m									10000 ± 300 mm				
	61110	CAT 8.1-1500 S/FTP AWG26 LSZH WHITE 15m									15000 ± 300 mm				
	61111	CAT 8.1-2000 S/FTP AWG26 LSZH WHITE 20m									20000 ± 300 mm				
G	61113	CAT 8.1-0025 S/FTP AWG26 LSZH GREY 0.25m GHMT			GHMT-zertifiziertes CAT 8.1 Patchkabel, S/FTP (PiMF) / GHMT-certified CAT 8.1 S/FTP Patch Cord				ja / yes		250 ± 10 mm		grau / grey		
	61114	CAT 8.1-0050 S/FTP AWG26 LSZH GREY 0.50m GHMT									500 ± 20 mm				
	61115	CAT 8.1-0100 S/FTP AWG26 LSZH GREY 1m GHMT									1000 ± 20 mm				
	61116	CAT 8.1-0200 S/FTP AWG26 LSZH GREY 2m GHMT									2000 ± 30 mm				
	61117	CAT 8.1-0300 S/FTP AWG26 LSZH GREY 3m GHMT									3000 ± 50 mm				
H	61118	CAT 8.1-0500 S/FTP AWG26 LSZH GREY 5m			CAT-8.1-Patchkabel, S/FTP (PiMF) / CAT 8.1 S/FTP Patch Cord				nein / no		5000 ± 100 mm				
	61119	CAT 8.1-0750 S/FTP AWG26 LSZH GREY 7.5m			RJ45-Patchkabel mit CAT 8.1 S/FTP Rohkabel / RJ45 Patch Cord with CAT 8.1 S/FTP Raw Cable						7500 ± 150 mm				
	61120	CAT 8.1-1000 S/FTP AWG26 LSZH GREY 10m									10000 ± 300 mm				
	61121	CAT 8.1-1500 S/FTP AWG26 LSZH GREY 15m									15000 ± 300 mm				
	61122	CAT 8.1-2000 S/FTP AWG26 LSZH GREY 20m									20000 ± 300 mm				
I	Änderungen			Datum		Name		Bezeichnung				Blatt			
	Datum			Name		gez.:	01.02.2023	ir	CAT 8.1-XXXX S/FTP AWG26 LSZH						
						gepr.:	01.02.2023	aw	X Xm						
						Norm:			Zeichnungs-Nr.:				von		
J						Änderungen vorbehalten / Subject to change									
1	2	3	4	5	6	7	8	9	10	11	12	13	14		